



swiss bed concept



# FINE LINE

MASSIVHOLZ | BOIS MASSIF | SOLID WOOD

Achten Sie auf FSC®-zertifizierte Produkte | Soyez attentifs aux produits certifiés FSC® | Look for FSC®-certified products



# Hasena – mein Bett

Hasena – mon lit | Hasena – my bed

## Beständige Passion

Une passion constante  
Enduring Passion



### Mehr als ein Lebenswerk

Als Familienunternehmen gegründet, überzeugen wir seit über 70 Jahren mit hoher Qualität und Vielseitigkeit im Bereich Schlafzimmermöbel.

### Plus que l'œuvre d'une vie

Fondée en tant qu'entreprise familiale, nous convainquons depuis plus de 70 ans par notre qualité élevée et notre polyvalence dans le domaine des meubles de chambre à coucher.

### More than a life's work

Founded as a family business, we have been impressing with high quality and versatility in the field of bedroom furniture for over 70 years.

## swiss bed concept



swiss bed concept

### Ein cleveres Baukastensystem

Sie wählen Ihren favorisierten Bettrahmen aus und kombinieren dazu Füße und Kopfteil Ihrer Wahl. Dabei können Sie quer durch die Kollektionen auf unterschiedliche Materialien und Farben zugreifen.

### Un système modulaire astucieux

Vous choisissez votre cadre de lit préféré et le combinez avec les pieds et les têtes de lit de votre choix. Vous pouvez choisir parmi une variété de matériaux et de couleurs dans toutes les collections.

### A clever modular system

You choose your favourite bed frame and combine it with the feet and headboards of your choice. You can choose from a variety of materials and colours throughout the collections.

## 5 Jahre Garantie

Service de livraison rapide  
5 years warranty



### Unser Versprechen

Vom Baum zum Bett – mittels handwerklicher Perfektion und hochwertigen Materialien. Sie erhalten 5 Jahre Garantie auf die Material- und Oberflächenbeschaffenheit, sowie die fachgerechte Verarbeitung aller Modelle ab Kaufdatum. Weitere Informationen finden Sie auf unserer Website.

### Notre promesse

De l'arbre au lit – grâce à un artisanat parfait et des matériaux de haute qualité. Vous bénéficiez d'une garantie de 5 ans sur la qualité des matériaux et des surfaces, ainsi que sur la fabrication professionnelle de tous les modèles à compter de la date d'achat. Vous trouverez plus d'informations sur notre site Internet.

### Our promise

From tree to bed – by means of perfect craftsmanship and high-quality materials. You receive a 5-year guarantee on the material and surface quality, as well as the professional workmanship of all models from the date of purchase. Further information can be found on our website.

## Schnellieferservice

Service de livraison rapide  
Quick delivery service



### Komfort ohne Wartezeit

Mit unserem Schnellieferservice «PRONTO» können wir eine grosse Auswahl an Betten mit Beimöbeln und alle Modelle aus Edition pronto, Dream pronto und Boxspring pronto ab Lager liefern.

### Le confort sans attente

Notre service de livraison rapide « PRONTO » permet de livrer un large choix de lits, de meubles d'appoint et tous les modèles de l'Édition Pronto, Dream pronto et Boxspring Pronto à partir du stock.

### Comfort without waiting

With our quick delivery service «PRONTO» we can offer a large selection of beds with ancillary furniture and all models from models from Edition pronto, Dream pronto and Boxspring pronto from stock.





## Vielseitig kombinierbar

Unser ausgeklügeltes Baukastensystem «swiss bed concept» bietet eine riesige Auswahl an Füßen, Kopfteilen und Beimöbeln. Darüber hinaus umfasst es verschiedene Stoff-, Kunstleder- und Lederbezüge sowie diverse Holz- und Metallausführungen. Abgestimmte Lattenroste und Matratzen komplettieren unsere Betten zur Wohlfühloase.

## Combinable à versatile

Notre système modulaire sophistiqué «swiss bed concept» propose un choix énorme de pieds, têtes de lits et accessoires. Par ailleurs le comporte différents tissus, cuirs synthétiques et véritables, ainsi que diverses variantes de bois et métal. Des sommiers à lattes et des matelas adaptés complètent nos lits pour un espace bien-être.

## Versatile combinable

Our ingenious modular system «swiss bed concept» offers a huge selection of feet, headboards and accessories. In addition, it includes different fabrics, synthetic leather and real leather covers and different wood and metal versions. Matching slatted frames and mattresses complete our beds to an oasis of well-being.

## Nachhaltigkeit bei Hasena

Unser wichtigster Lieferant, die Natur, ist sensibel und benötigt lange Regenerationszeiten bei Überbeanspruchung. Wir respektieren die von uns genutzten Ökosysteme und stellen unsere Produkte nachhaltig und mit hohem sozialen Engagement her.



## Soziale Verantwortung

Responsabilité sociale  
Social responsibility



## Holzoberflächen

Surfaces en bois  
Wood surfaces



## Stabil im Aufbau

Unsere Betten überzeugen durch eine hohe Stabilität. Mittels Einsatz verschiedener Traversen ist eine gesamthafte Belastung von 300 bis 450 kg, inklusive Lattenroste und Matratzen, möglich.

## Construction robuste

Nos lits sont convainçants par leur grande stabilité. En utilisant différentes fermes, une charge totale de 300 à 450 kg, y compris les sommiers à lattes et les matelas, est possible.

## Solid in construction

Our beds convince with their high stability. By using different trusses, a total load of 300 to 450 kg, including slatted frames and mattresses, is possible.

## Durabilité chez Hasena

Notre fournisseur le plus important, la nature, est sensible et nécessite un long temps de régénération en cas de surutilisation. Nous respectons les écosystèmes que nous utilisons et fabriquons nos produits de manière durable et avec un haut niveau d'engagement social.



## Holzbeschaffung

Approvisionnement en bois  
Wood procurement



## Recycelte Stoffe

Tissus recyclés  
Recycled fabrics



## Einfach in der Montage

Unser Betten-System begeistert durch einen einfachen Aufbau mit leicht verständlicher Montageanleitung sowie hochwertigen Verbindungselementen, welche einen vielfachen Ab- und Wiederaufbau ermöglichen.

## Montage facile

Notre système de lits séduit par une installation facile grâce aux instructions de montage bien compréhensibles ainsi que par les éléments de fixation haut de gamme permettant de monter et démonter les lits à de nombreuses reprises.

## Solid in construction

Our beds convince with their high stability. By using different trusses, a total load of 300 to 450 kg, including slatted frames and mattresses, is possible.

## Sustainability at Hasena

Our most important supplier, nature, is sensitive and needs long regeneration times in case of overuse. We respect the ecosystems we use and manufacture our products sustainably and with a high level of social commitment.



## Produktion Massivholz

Production bois massif  
Manufacturing solid wood



## Energiegewinnung

Production énergétique  
Production of energy



# Bettrahmen | Cadre de lit | Bedframe



## Syma 18

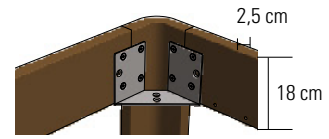

**Breiten** | Largeurs | Widths:  
90, 100, 120, 140, 160, 180, 200 cm

**Längen** | Longueurs | Lengths:  
190, 200, 210, 220 cm

**Einlegetiefe** | Hauteur encastrable | Insertion depth:  
18 cm

## Traversen | Traverses | Bars

**Wir empfehlen grundsätzlich den Einsatz von Crosstraver (Quertraverse) oder Midtraver (Längstraverse).**

Nous recommandons en général l'utilisation de Crosstraver (traverse transversale) ou Midtraver (traverse centrale).

We recommend basically the insertion of Crosstraver (central cross bar) or Midtraver (central bar).

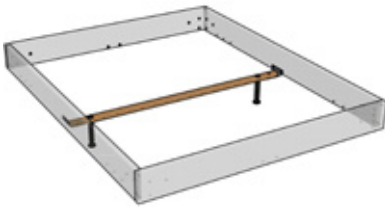

### Crosstraver

Quertraverse | Traverse transversale | Central cross bar

**Für alle Bettbreiten** | Pour toutes les largeurs de lit | For all bed widths

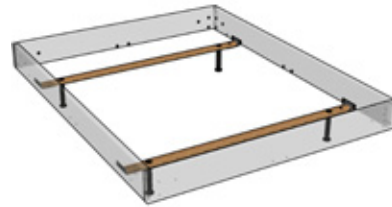

### Crosstraver-Twin

Quertraversen | Traverses transversales | Cross bars

**Für alle Bettbreiten** | Pour toutes les largeurs de lit | For all bed widths

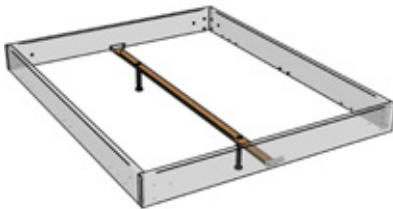

### Midtraver

Längstraverse | Traverse centrale | Central bar

**Für Betten ab Breite 140 cm mit 2 Lattenrosten oder Motorrahmen-einbau** | Pour les lits à partir de 140 cm de largeur avec 2 sommiers ou l'installation d'un cadre motorisé | For beds from 140 cm width with 2 slats or motor frame installation

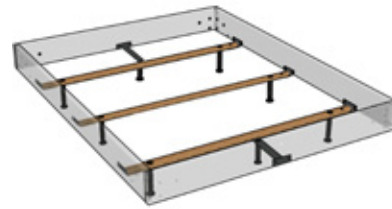

### Crosstraver-XXL

Quertraversen | Traverses transversales | Cross bars

**Für alle Bettbreiten** | Pour toutes les largeurs de lit | For all bed widths

**Übersicht Kompatibilität Traversen siehe Gesamtkatalog Seite 2.12** | Aperçu compatibilité traverses voir catalogue général page 2.12 | Overview compatibility bars see general catalogue page 2.12

## Ausführungen | Exécutions | Executions

### Holz | Bois | Wood

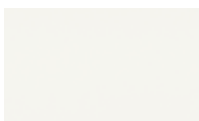

**10**  
**Buche weiss**  
**deckend, lackiert**

Hêtre blanc couvrant, laqué  
Beech white covered,  
lacquered



**80**  
**Kernbuche natur, geölt**  
Hêtre cœur rouge  
naturel, huilé  
Heart beech natural, oiled

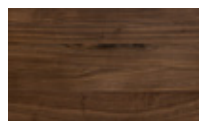

**82**  
**Nussbaum, geölt**  
Noyer, huilé  
Walnut, oiled

# Füsse | Pieds | Feet



**Facito**



**Masito**



**Syko**



**Tondito**



**Ronda**



**Xylo**



**Lovie-Ron Box**



90–140 (1 Schublade/Tiroir/Drawer)  
140–200 (2 Schubladen/Tiroirs/Drawers)

**Practico-Ron Box**



**Airo**



**Eviron**



**\*Cielo-Ron**

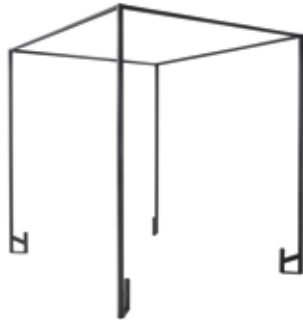

**\*Curty Vorhang und Vela Baldachin-Tuch siehe Gesamtkatalog Seite 2.7**

Curty rideau et Vela tissu de baldachin voir catalogue général page 2.7  
Curty curtain and Vela canopy cloth see general catalogue page 2.7

**Slitto**

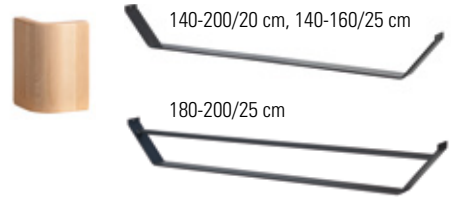

## Holz | Bois | Wood

	Breiten cm Largeurs cm Widths cm	Höhen cm Hauteurs cm Heights cm			Holzfarben Couleurs bois Colours wood			
		20	25	30	10	16	80	82
Airo	90–200	●	■		●	■	●	■
Eviron	90–200		●		●	●	●	■
Lovie-Ron Box (1 Schublade/Tiroir/Drawer)	90–140		●		●	●	●	■
Lovie-Ron Box (2 Schubladen/Tiroirs/Drawers)	140–200		●		●	●	●	■
Practico-Ron Box*	90–200		●		●	●	●	
Masito		●	●		●	■	●	●
Ronda		●	●	●	●	■	●	●
Xylo		●	●	●	●	■	●	●

**Kufen und Boxfronten ausschliesslich in weiss oder anthrazit** | Patins et façades box exclusivement en blanc ou en anthracite | Vats and box fronts in white or anthracite only

## Holz | Bois | Wood

**10**  
**Buche weiss deckend, lackiert**  
Hêtre blanc couvrant, laqué  
Beech white covered, lacquered

**80**  
**Kernbuche natur, geölt**  
Hêtre cœur rouge naturel, huilé  
Heart beech natural, oiled

**82**  
**Nussbaum, geölt**  
Noyer, huilé  
Walnut, oiled

**16**  
**Buche anthracit deckend, lackiert**  
Hêtre blanc couvrant, laqué  
Beech white covered, lacquered

**\*weiss/anthracit = MDF**  
blanc/anthracite = MDF  
white/anthracite = MDF

## Metall | Métal | Metal

	Breiten cm Largeurs cm Widths cm	Höhen cm Hauteurs cm Heights cm			Metallfarben Couleurs métal Colours metal			
		20	25	30	00	10	16	42
Cielo-Ron <sup>▲</sup>	120–200	●	■			●	●	
Facito		●					●	
Syko		●	●	●	●	■	●	■
Slitto	140–200	●	●			●	●	●
Tondito		●					●	●

## Metall | Métal | Metal

**00**  
**Chrom**

**10**  
**White**

**16**  
**Anthracit**

**42**  
**Alu**

**00 Chrom = Metall verchromt** | Métal chromé | Metal chrome  
**10 White = Metall pulverbeschichtet** | Métal thermolaqué | Metal powder-coated  
**16 Anthracit = Metall pulverbeschichtet** | Métal thermolaqué | Metal powder-coated  
**42 Alu = Stahl pulverbeschichtet** | Métal thermolaqué | Metal powder-coated

# Kopfteile | Têtes de lit | Headboards



## Duetto



Dimension: 90/100, 120, 140, 160, 180, 200

## Vola

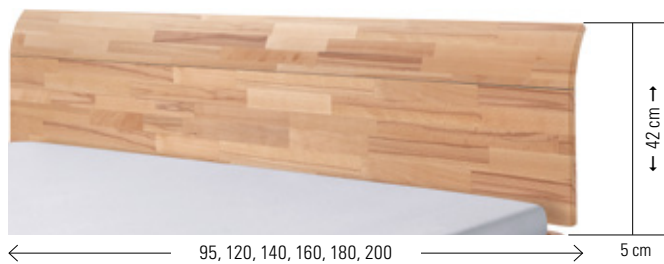

Dimension: 90/100, 120, 140, 160, 180, 200

## gepolstert | rembourrées | upholstered

### Cemoa\*



Dimension: 90, 100, 120, 140, 160, 180, 200 (90–120 = 1 Kissen | Coussin | Cushion)

**Gewünschte Liegefläche (Länge)** = zu bestellende **Bettrahmenlänge**  
 Surface de couchage souhaitée (longueur) = longueur de cadre de lit à commander  
 Desired mattress lying area (length) = length of bedframe to be ordered

<b>190</b>	<b>= 200</b>
<b>200</b>	<b>= 210</b>
<b>210</b>	<b>= 220</b>

## Varus



Dimension: 140, 160, 180, 200

## Adapter | Adaptateur | Adapter

**Bei hohen Matratzen kann mit dem Verlängerungsadapter das Kopfteil erhöht werden.** | La tête de lit peut être rehaussée avec l'adaptateur lorsque le matelas est plus épais. | With the extension adapter the headboard can be extended if mattresses are high.

**Head-Plus** (2er Set | set of 2 | set of 2)

**Metall** | Métal | Metal

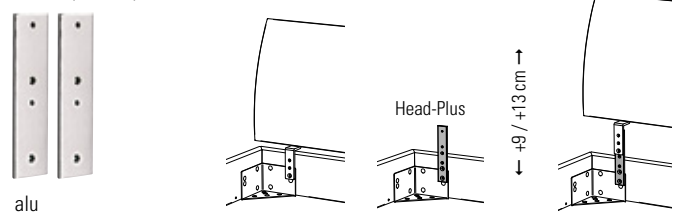

## Leselampe | Lampe de lecture | Reading lamp

**Leselampe bei Holz- und gepolsterten Kopfteilen montierbar**

La lampe de lecture peut être montée sur des têtes de lit en bois et rembourrées-  
 Reading lamp can be assembled on wooden an upholstered headboards

**Smart black** (2er Set | set of 2 | set of 2)



**Weitere Leselampen und technische Details siehe Gesamtkatalog Register 2, Seite 2.11**

Autres lampes de lecture et détails techniques voir catalogue général registre 2, page 2.11

Further reading lamps and technical details see general catalogue index 2, page 2.11

**\*Das Kopfteil Cemoa enthält in Echtleder keine Teilungsnähte.**

En cuir véritable, la tête de lit Cemoa ne comporte pas de coutures de séparation.  
 The Cemoa headboard contains no dividing seams in genuine leather.

## Ausführungen | Exécutions | Executions

### Holz | Bois | Wood

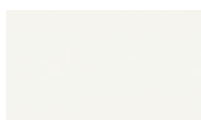

**10**  
**Buche weiss**  
**deckend, lackiert**  
 Hêtre blanc couvrant, laqué  
 Beech white covered,  
 lacquered



**80**  
**Kernbuche natur, geölt**  
 Hêtre cœur rouge  
 naturel, huilé  
 Heart beech natural, oiled

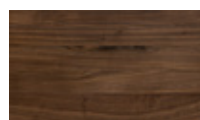

**82**  
**Nussbaum, geölt**  
 Noyer, huilé  
 Walnut, oiled

# Kissen zu Kopfteilen | Coussins pour têtes de lit | Cushions for headboards

**Arona + Duetto**



**Lumo + Duetto**



**Ravo + Varus**



**Suny + Varus**



**Varo + Varus**



## Befestigung mit 2 Bändern (Klettverschluss)

Fixation avec 2 bandes (Velcro®)

Fixation with 2 ribbons (Velcro® fastener)

## Stoffauswahl/Farben für Kissen siehe Gesamtkatalog

**Register 1, Seiten 1.6–1.7** | Choix de tissus/couleurs pour coussins voir catalogue général registre 1, pages 1.6–1.7 | Choice of tissues/colours for cushions see general catalogue index 1, pages 1.6–1.7

**Alle Kissen in Echtleder haben Zier- sowie Teilungsnähte. Ausnahmen: Suny und Varo, diese Kissen haben lediglich Ziernähte.**

Tous les coussins en cuir véritable ont des coutures décoratives et des coutures de séparation. A l'exception des coussins : Suny et Varo, ces coussins ont uniquement des coutures décoratives.

All cushions in genuine leather have decorative and dividing seams. Exceptions: Suny and Varo, these cushions only have decorative seams.

## Kissen | Coussins | Cushions

	<b>Effektive Masse cm</b> Dimension effective cm Effective dimension cm
Arona	86, 116, 136, 156, 176×3,5×25
Lumo	86, 116, 136, 156, 176×6×25
Ravo	80, 110, 130, 150, 170, 190×3,5×35
Suny 2er Set   set de 2   set of 2	55×6×40
Varo 2er Set   set de 2   set of 2	55×10×35

## zu Kopfteilen pour têtes de lit for headboards

	Duetto	Varus
	●	
	●	
	●	●
	●	●
	●	●

## Breitenmasse cm

Dimensions de largeur cm  
Widths dimensions cm

90/100, 120, 140, 160, 180/200

90/100, 120, 140, 160, 180/200

90/100, 120, 140, 160, 180, 200



# selezione

## 01

### MODELLAUSWAHL

Sélection du modèle | Model selection

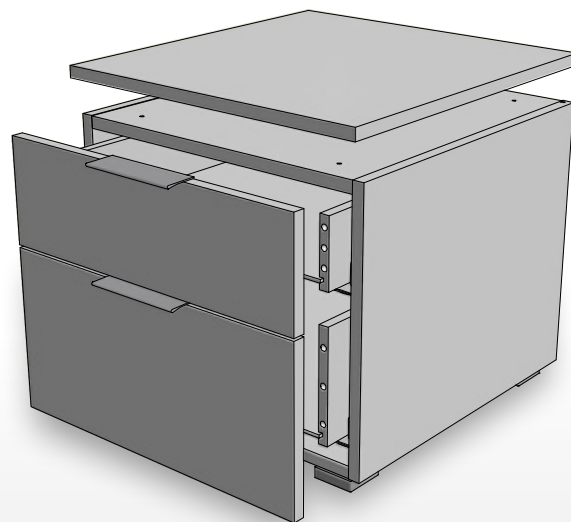

Twia



45/50/41 cm

Onia



45/50/41 cm

Owita



90/50/41 cm

Trio



45/50/55 cm

Dowe



45/50/55 cm

Dowio



90/50/55 cm

Quatro



45/50/86 cm

Unito



45/50/86 cm

Qunito



90/50/86 cm

Quatrine



90/50/86 cm

Portina



90/50/86 cm

Atrine



90/50/86 cm

Totrino



135/50/86 cm

Cassino



135/50/86 cm

Incentro



135/50/86 cm

Trequatri



135/50/86 cm

Stellen Sie sich Ihr Wunsch-Beimöbel nach Ihrem Geschmack zusammen: Der Korpus (Abb. 02), in zwei verschiedenen Farbvarianten, lässt sich zu den Front- und Top-Covern (Abb. 03) in acht Holz- und Farbausführungen kombinieren. Die Beimöbel können zerlegt oder teilmontiert bestellt werden. Bei zusammengesetzten Möbeln (z. B. Qunito, Incentro, ...) muss der Deckel noch montiert werden. Bei Kommoden mit Türen ist jeweils ein Einlegeboden vorhanden, Türöffnung nach links oder rechts möglich. Zusätzliche Böden sind erhältlich.

Composez le meuble d'appoint de vos rêves selon vos goûts : Le caisson (ill. 02), disponible en 2 variantes de couleurs, peut être combiné avec les façades et couvercles supérieurs (ill. 03) en 8 finitions de bois et de coloris. Les meubles d'appoint peuvent être commandés en kits ou assemblés. Pour les meubles assemblés (p. ex. Qunito, Incentro, ...) le couvercle doit encore être fixé. Les commodes avec portes sont équipées d'une étagère, ouverture de la porte possible à gauche ou à droite. Si besoin, des étagères supplémentaires sont disponibles.

Put together the side furniture you want according to your own taste: The body (fig. 02), in two different colour versions, can be combined with the front and top covers (fig. 03) in eight wood and colour versions. The furniture can be ordered disassembled or assembled. For assembled furniture (e.g. Qunito, Incentro, ...) the top cover must still be fitted. Chests of drawers with doors have one shelf, door opening possible to the left or right. Additional shelves are available.



**Kombinationsbeispiele und techn. Informationen**  
Exemples et informations  
Examples and informations



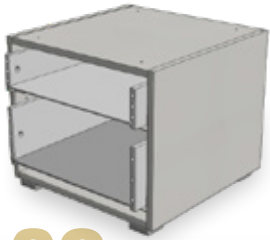

# 02

## KORPUS

Caisson | Body



# 03

## TOP/FRONT

Farben | Couleurs | Colours

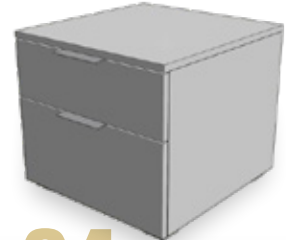

# 04

## GRIFFE

Poignées | Handles



10 Weiss | Blanc | White



16 Anthracit | Anthracite



## FÜSSE

Pieds | Feet

### STANDARD



### OPTION

Leg 8 cm

Jone 10 cm

Cila 10 cm



Alu



Anthracit  
Used



Anthracit



10 Weiss | Blanc | White



16 Anthracit | Anthracite

### STANDARD



Alu

#### Griff zu Folienfronten

Poignée pour façades en mélaminé  
Handle for foil fronts

### STANDARD



#### Holzgriff zu Holzfronten

Poignée en bois pour façades en bois  
Wooden handle for wooden fronts

### OPTION

Rivo



Used



Anthracit

#### Metalgriff zu Holzfronten

Poignée en métal pour façades en bois  
Metal handle for wooden fronts



74 Eiche bright, geölt  
Chêne bright, huilé  
Oak bright, oiled

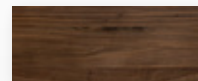

82 Nussbaum, geölt  
Noyer, huilé  
Walnut, oiled



76 Eiche brandy, geölt  
Chêne brandy, huilé  
Oak brandy, oiled



87 Wildbuche natur, geölt  
Hêtre nouveau naturel, huilé  
Wildbeech natural, oiled

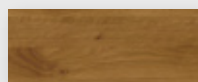

99 Wildeiche natur, geölt  
Chêne nouveau naturel, huilé  
Wildoak natural, oiled



80 Kernbuche natur, geölt  
Hêtre coeur rouge naturel, huilé  
Heart beech natural, oiled



The mark of  
responsible forestry  
FSC® C123546

Look for FSC® certified products



				Dimension cm
<b>Sola</b>	Bank	Banquette	Bench	140/37/38
<b>Topia</b>	Kissen, Capo linen 763	Coussin, Capo linen 763	Cushion, Capo linen 763	140/37/10
<b>Trigo</b>	Nachttisch	Table de nuit	Bedside table	48/43/55

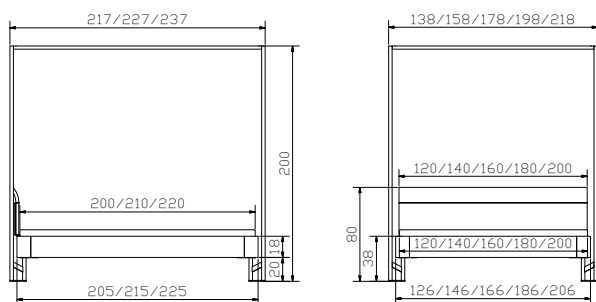



				<b>Dimension cm</b>
<b>Syma 18</b>	Rahmen Breiten Längen	Cadre Largeurs Longueurs	Frame Widths Lengths	120, 140, 160, 180, 200 200, 210, 220
<b>Cielo-Ron</b> anthracit	Baldachin Breiten Längen Höhe	Baldaqin Largeurs Longueurs Hauteur	Canopy Widths Lengths Height	120, 140, 160, 180, 200 200, 210, 220 20
<b>Vela</b>	Baldachin-Tuch, Baumwolle weiss Breiten Länge	Tissu de baldaqin, coton blanc Largeurs Longueur	Canopy cloth, cotton white Widths Length	120, 140, 160, 180, 200 200
<b>Vola</b>	Kopfteil	Tête de lit	Headboard	120, 140, 160, 180, 200

**Alle Holzteile in Nussbaum, geölt** | Toutes les parties en bois en noyer, huilé | All wooden parts in walnut, oiled

**Weitere Beimöbel siehe Gesamtkatalog Register 2** | Autres accessoires voir catalogue général registre 2 | Further accessories see general catalogue index 2



				Dimension cm
<b>Sola</b>	Bank	Banquette	Bench	140/37/38
<b>Vano</b>	Kissen, Kitana beige 600	Coussin, Kitana beige 600	Cushion, Kitana beige 600	136/34/4
<b>Claudio alu</b>	Herrendiener	Valet	Dressboy	45/28/107
<b>Noma</b>	Nachtisch	Table de nuit	Bedside table	48/43/39



**Details siehe Seite Gesamtkatalog 8.7**

Détails voir catalogue général page 8.7

Details see general catalogue page 8.7



				Dimension cm
<b>Syma 18</b>	Rahmen Breiten Längen	Cadre Largeurs Longueurs	Frame Widths Lengths	90, 100, 120, 140, 160, 180, 200 200, 210, 220
<b>Practico-Ron Box</b>	Breiten Längen Höhe	Largeurs Longueurs Hauteur	Widths Lengths Height	90, 100, 120, 140, 160, 180, 200 200, 210, 220 25
<b>Ripo</b>	Kopfteil, Kitana beige 600 siehe Gesamtkatalog Register 1	Tête de lit, Kitana beige 600 voir catalogue général registre 1	Headboard, Kitana beige 600 see general catalogue index 1	90, 100, 120, 140, 160, 180, 200

**Alle Holzteile in Kernbuche natur, geölt** | Toutes les parties en bois en hêtre cœur rouge naturel huilé | All wooden parts in heart beech natural, oiled

**Weitere Beimöbel siehe Gesamtkatalog Register 2** | Autres accessoires voir catalogue général registre 2 | Further accessories see general catalogue index 2

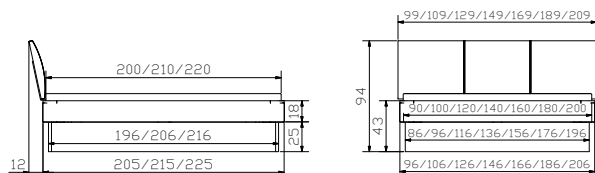



				Dimension cm
<b>Sigma</b>	Kommode	Commode	Chest of drawers	120/49/76
<b>Cila 10 anthracit</b>	Füsse	Pieds	Feet	
<b>Noma</b>	Nachttisch	Table de nuit	Bedside table	48/43/39
<b>Cila 10 anthracit</b>	Füsse	Pieds	Feet	

**Alle Holzteile in Nussbaum, geölt** | Toutes les parties en bois en noyer, huilé | All wooden parts in walnut, oiled

**Leselampen und weitere Beimöbel siehe Gesamtkatalog Register 2** | Lampes de lecture et autres accessoires voir catalogue général registre 2 | Reading lamps and further accessories see general catalogue index 2



				Dimension cm
<b>Syma 18</b>	Rahmen Breiten Längen	Cadre Largeurs Longueurs	Frame Widths Lengths	90, 100, 120, 140, 160, 180, 200 190, 200, 210, 220
<b>Facito anthracit</b>	Eckfüsse Höhe	Pieds d'angles Hauteur	Corner feet Height	20
<b>Vola</b>	Kopfteil	Tête de lit	Headboard	90/100, 120, 140, 160, 180, 200

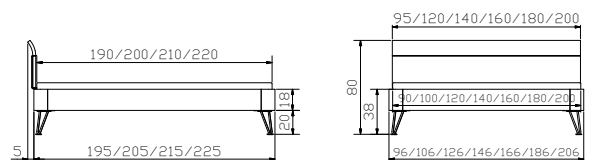



				Dimension cm
<b>Sola</b>	Bank	Banquette	Bench	140/37/38
<b>Vano</b>	Kissen, Boucle fresco 772	Coussin, Boucle fresco 772	Cushion, Boucle fresco 772	136/34/4
<b>Aska</b>	Sekretär	Secrétaire	Bureau	120/60/85
<b>Caja</b>	Nachttisch	Table de nuit	Bedside table	48/41/16
<b>Smart white</b>	Leselampe (2er Set) 12V DC, 30 LED warm	Lampe de lecture (set de 2) 12V DC, 30 LED warm	Reading lamp (set of 2) 12V DC, 30 LED warm	

**Alle Holzteile in Buche weiss deckend, lackiert** | Toutes les parties en bois en hêtre blanc couvrant, laqué | All wooden parts in beech white covered, lacquered  
**Leselampen und weitere Beimöbel siehe Gesamtkatalog Register 2** | Lampes de lecture et autres accessoires voir catalogue général registre 2 | Reading lamps and further accessories see general catalogue index 2





				<b>Dimension cm</b>
<b>Syma 18</b>	Rahmen Breiten Längen	Cadre Largeurs Longueurs	Frame Widths Lengths	90, 100, 120, 140, 160, 180, 200 190, 200, 210, 220
<b>Xylo</b>	Eckfüsse Höhen	Pieds d'angles Hauteurs	Corner feet Heights	20(38), 25(43), 30(48)
<b>Vola</b>	Kopfteil	Tête de lit	Headboard	90/100, 120, 140, 160, 180, 200

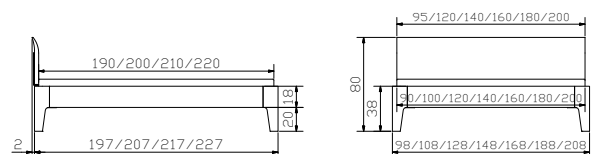



				Dimension cm
<b>Lovie-Ron Box</b>	1 Bettkasten	1 Tiroir de lit	1 Bed drawer	90, 100, 120, 140
	Breiten	Largeurs	Widths	
	2 Bettkästen	2 Tiroirs de lit	2 Bed drawers	140, 160, 180, 200
	Breiten	Largeurs	Widths	
	Höhe	Hauteur	Height	25

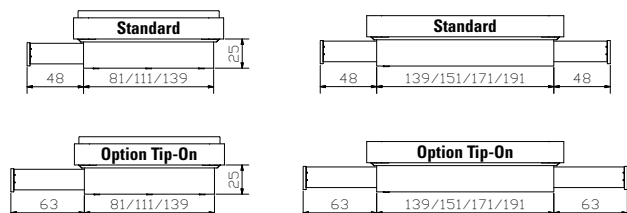



				Dimension cm
<b>Syma 18</b>	Rahmen Breiten Längen	Cadre Largeurs Longueurs	Frame Widths Lengths	90, 100, 120, 140, 160, 180, 200 190, 200, 210, 220
<b>Boga</b>	Kopfteil, Fusio shell 750 siehe Gesamtkatalog Register 1	Tête de lit, Fusio shell 750 voir catalogue général registre 1	Headboard, Fusio shell 750 see general catalogue index 1	90, 100, 120, 140, 160, 180, 200
<b>Sigma Sima 20</b>	Kommode Füsse	Commode Pieds	Chest of drawers Feet	120/49/86
<b>Noma Sima 10</b>	Nachttisch Füsse	Table de nuit Pieds	Bedside table Feet	48/43/47

**Alle Holzteile in Buche weiss deckend, lackiert**

Toutes les parties en bois en hêtre blanc couvrant, laqué  
All wooden parts in beech white covered, lacquered

**Weitere Beimöbel siehe Gesamtkatalog Register 2** | Autres accessoires voir catalogue général registre 2 | Further accessories see general catalogue index 2

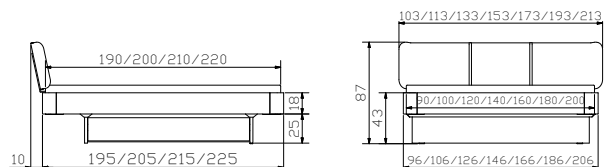



				<b>Dimension cm</b>
<b>Quatro</b>	Kommode	Commode	Chest of drawers	45/49/85
<b>Twia</b>	Nachttisch	Table de nuit	Bedside table	45/49/40

**Alle Holzteile in Buche weiss deckend, lackiert oder weiss** | Toutes les parties en bois en hêtre blanc couvrant, laqué ou blanc | All wooden parts in beech white covered, lacquered or white

**Weitere Beimöbel siehe Gesamtkatalog Register 2** | Autres accessoires voir catalogue général registre 2 | Further accessories see general catalogue index 2



				<b>Dimension cm</b>
<b>Syma 18</b>	Rahmen Breiten Längen	Cadre Largeurs Longueurs	Frame Widths Lengths	140, 160, 180, 200 190, 200, 210, 220
<b>Slitto white</b>	Kufen Breiten Höhen	Patins Largeurs Hauteurs	Vats Widths Heights	140, 160, 180, 200 20, 25
<b>Cussina</b>	Kopfteil, Boston clay 650 siehe Gesamtkatalog Register 1	Tête de lit, Boston clay 650 voir catalogue général registre 1	Headboard, Boston clay 650 see general catalogue index 1	140, 160, 180, 200

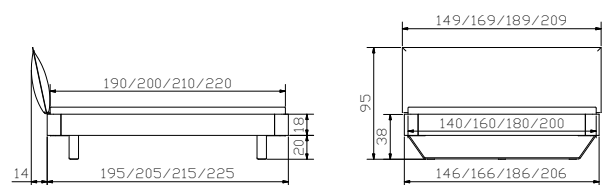



**Circo 44**

Nachttisch

Table de nuit

Bedside table

**Dimension cm**

Ø 45/44

**Alle Holzteile in Nussbaum, geölt** | Toutes les parties en bois en noyer, huilé | All wooden parts in walnut, oiled

**Weitere Beimöbel siehe Gesamtkatalog Register 2** | Autres accessoires voir catalogue général registre 2 | Further accessories see general catalogue index 2



				<b>Dimension cm</b>
<b>Syma 18</b>	Rahmen Breiten Längen	Cadre Largeurs Longueurs	Frame Widths Lengths	90, 100, 120, 140, 160, 180, 200 190, 200, 210, 220
<b>Xylo</b>	Eckfüsse Höhen	Pieds d'angles Hauteurs	Corner feet Heights	20(38), 25(43), 30(48)
<b>Vola</b>	Kopfteil	Tête de lit	Headboard	90/100, 120, 140, 160, 180, 200

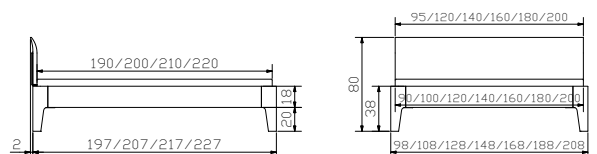



				Dimension cm
<b>Topa</b> anthracit	Bank, inkl. Kissen Fusio shell 750	Banquette, coussin incl. Fusio shell 750	Bench, cushion incl. Fusio shell 750	144/44/38
<b>Quatro</b>	Kommode	Commode	Chest of drawers	45/50/86
<b>Nali</b> anthracit	Nachttisch	Table de nuit	Bedside table	Ø 48//52
<b>Smart</b> black	Leselampe (2er Set) schwarz 12V DC, 30 LED warm Dreistufenschaltung	Lampe de lecture (set de 2) noir 12V DC, 30 LED warm Interrupteur à 3 crans	Reading lamp (set of 2) nero 12V DC, 30 LED warm Three step circuit	

**Alle Holzteile in Nussbaum, geölt** | Toutes les parties en bois en noyer, huilé | All wooden parts in walnut, oiled

**Quatro: Korpus anthracit** | Caisson anthracite | Body anthracite

**Leselampen und weitere Beimöbel siehe Gesamtkatalog Register 2** | Lampes de lecture et autres accessoires voir catalogue général registre 2 | Reading lamps and further accessories see general catalogue index 2





				<b>Dimension cm</b>
<b>Syma 18</b>	Rahmen Breiten Längen	Cadre Largeurs Longueurs	Frame Widths Lengths	140, 160, 180, 200 190, 200, 210, 220
<b>Tondito anthracit</b>	Eckteile + Füße Höhe	Pièces d'angles + pieds Hauteur	Corner pieces + feet Height	20
<b>Sogno L</b>	Wandpaneele Fusio shell 750 siehe Gesamtkatalog Register 1	Panneaux muraux Fusio shell 750 voir catalogue général registre 1	Wallpanel Fusio shell 750 see general catalogue index 1	161, 181, 201, 221

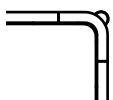

Der Fuss Tondito ragt 17 mm über das Eckteil.  
Le pied Tondito dépasse de 17 mm de la pièce d'angle.  
The Tondito feet protrudes 17 mm over the corner piece.

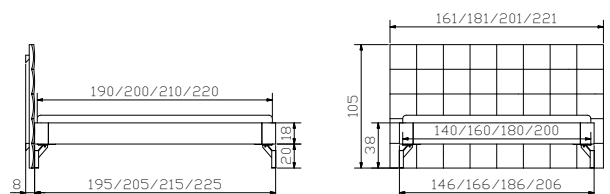



				<b>Dimension cm</b>
<b>Sola</b>	Bank	Banquette	Bench	140/37/38
<b>Vano</b>	Kissen, Boucle mouse 773	Coussin, Boucle mouse 773	Cushion, Boucle mouse 773	136/34/4
<b>Circo 44</b>	Nachttisch	Table de nuit	Bedside table	∅ 45/44

**Alle Holzteile in Nussbaum, geölt** | Toutes les parties en bois en noyer, huilé | All wooden parts in walnut, oiled

**Weitere Beimöbel siehe Gesamtkatalog Register 2** | Autres accessoires voir catalogue général registre 2 | Further accessories see general catalogue index 2



				<b>Dimension cm</b>
<b>Syma 18</b>	Rahmen Breiten Längen	Cadre Largeurs Longueurs	Frame Widths Lengths	90, 100, 120, 140, 160, 180, 200 190(200), 200(210), 210(220)
<b>Xylo</b>	Eckfüsse Höhen	Pieds d'angles Hauteurs	Corner feet Heights	20(38), 25(43), 30(48)
<b>Cemoa</b>	Kopfteil, Boucle mouse 773 hat Einfluss auf Bettlänge siehe Seite 6	Tête de lit, Boucle mouse 773 a un impact sur la longueur du lit voir page 6	Headboard, Boucle mouse 773 affects the length of bed see page 6	90, 100, 120, 140, 160, 180, 200 90 – 120 = 1 Kissen/Coussin/ Cushion

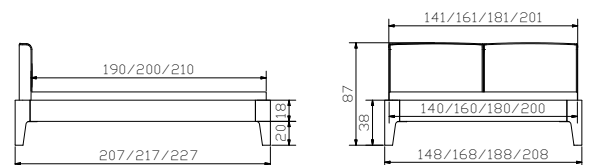



				<b>Dimension cm</b>
<b>Aska</b>	Sekretär	Secrétaire	bureau	120/60/85
<b>Sola</b>	Bank	Banquette	bench	140/37/38
<b>Topia</b>	Kissen, Capo taupe 765	Coussin, Capo taupe 765	cushion, Capo taupe 765	140/37/10
<b>Trigo</b>	Nachttisch	Table de nuit	bedside table	48/43/55

**Alle Holzteile in Kernbuche natur, geölt** | Toutes les parties en bois en hêtre cœur rouge naturel, huilé | All wooden parts in heart beech natural, oiled  
**Weitere Beimöbel siehe Gesamtkatalog Register 2** | Autres accessoires voir catalogue général registre 2 | Further accessories see general catalogue index 2



				<b>Dimension cm</b>
<b>Syma 18</b>	Rahmen Breiten Längen	Cadre Largeurs Longueurs	Frame Widths Lengths	140, 160, 180, 200 190, 200, 210, 220
<b>Ronda</b>	Eckfüsse Höhen	Pieds d'angles Hauteurs	Corner feet Heights	20(38), 25(43), 30(48)
<b>Umbia L</b>	Wandpaneel Capo taupe 765 nur für Wandmontage siehe Gesamtkatalog Register 1	Panneau mural Capo taupe 765 uniquement pour montage mural voir catalogue général registre 1	Wall panel Capo taupe 765 wall assembly only see general catalogue index 1	153, 173, 193, 213

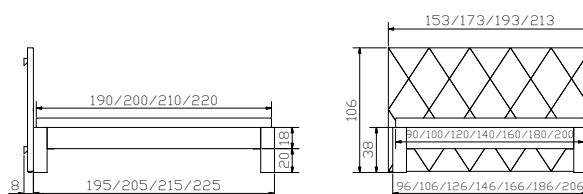



				<b>Dimension cm</b>
<b>Aska</b>	Sekretär	Secrétaire	Bureau	120/60/85
<b>Noma</b>	Nachttisch	Table de nuit	Bedside table	48/43/39
<b>Sima 10</b>	Füsse	Pieds	Feet	

**Alle Holzteile in Nussbaum, geölt** | Toutes les parties en bois en noyer, huilé | All wooden parts in walnut, oiled

**Weitere Beimöbel siehe Gesamtkatalog Register 2** | Autres accessoires voir catalogue général registre 2 | Further accessories see general catalogue index 2



				<b>Dimension cm</b>
<b>Syma 18</b>	Rahmen Breiten Längen	Cadre Largeurs Longueurs	Frame Widths Lengths	90, 100, 120, 140, 160, 180, 200 190, 200, 210, 220
<b>Masito</b>	Eckteile + Füße Höhen	Pièces d'angles + pieds Hauteurs	Corner pieces + feet Heights	20, 25
<b>Vola</b>	Kopfteil	Tête de lit	Headboard	90/100, 120, 140, 160, 180, 200

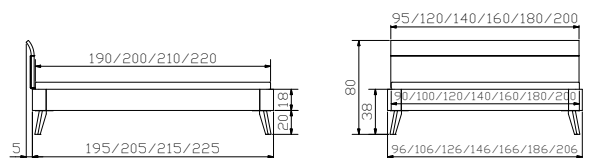



**MOVIE-/TOP LINE**



**FACTORY LINE**



**WOOD LINE**



**LOUNGE**



**FINE LINE**



**NATURO LINE**



**OAK LINE**



**OAK WILD**



**DREAM LINE**



**EDITION  
BOXSPRING**



**FUNCTION/COMFORT  
KIDS & GUESTS**



**LATTENROSTE &  
MATRATZEN**



**Gesamtkatalog**  
Catalogue général  
General catalogue